

中文 / EN

# News 新产品

2021/04

  
**BERGEON**

SWISS MADE SINCE 1791  
成立于1791年

**BERGEON**  
MANUFACTURED  
原厂制造

大约10年前，我们开始以【原厂制造】为目标，不断扩充机械加工部门，逐步添置设备。如今，我们的车间已占地超过1,500平方米，拥有大约20台最新一代的CNC数控机床，其中几台还配备了加工机器人，生产部门员工佔全公司员工60%以上，大部分产品都已经是BERGEON【原厂制造】。

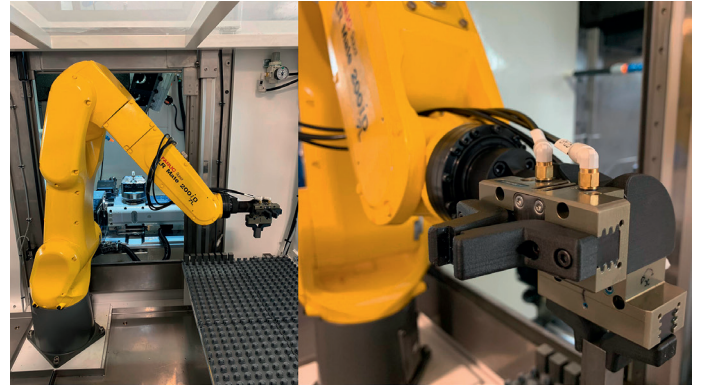

数控加工机器人



防震工具箱

2017年底，我们搬迁到拉绍德封技术园区，新厂房总面积接近4,000平方米。生产部现有近40名员工，仍在不断扩充，并加强产品研发，涵盖车削、铣削、采用纤维和有机技术的激光雕刻、切割、冲压、3D打印等等。大型装配车间，组装和包装产品；质检部门，保证制成品质量。此外，还有20多名员工，负责人力资源、行政、采购、营销及销售，10多名员工负责物流，合共超过70名员工，延续我们这家历史悠久的瑞士制造商传统，销售种类繁多的钟表工具及设备到110多个国家。最后，Bergeon一直支持青少年培训计划，招聘了大约十多名学徒，在营销、生产及物流等部门接受培训。

除了我们自行设计和制造的产品外，我们有部分【瑞士制造】产品，仍继续与瑞士其他具有精湛工艺技术的制造商合作生产。



激光雕刻车间



CNC数控机床车间



**BERGEON**  
MANUFACTURED

*It's a major objective to acquire manufacturing status. This transformation, which began almost 10 years ago, is now materializing in an activity in which more than 60% of employees are dedicated to the production of equipment and tools marketed by the company. Since then, the machining sector has continued to grow and now occupies an area of more than 1,500 m<sup>2</sup>. Thus, Bergeon has gradually acquired a fleet of latest generation machines with around twenty CNCs, several of which are equipped with robots, making it possible to produce a large part of the range of products labeled «Bergeon manufacture».*



«amplitude» kit 防震工具箱

*However, although strongly integrated in the design and manufacture of this new line of products, the company continues to collaborate with its network of regional subcontractors, possessing strong industrial skills and with which it realizes part of its label products «Swiss made».*



Assembly department 装配车间

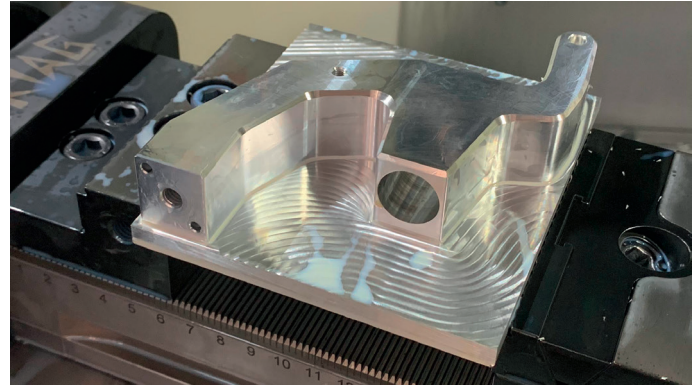

Draft press 31300 压铸锥形

*Installed since the end of 2017 in its new premises, in the technological park of Sentiers in La Chaux-de-Fonds, the company deploys its industrial activities on nearly 4000 m<sup>2</sup> and integrates in its manufacturing process, R + D, the unit of CNC production in bar turning, turning and milling, laser engraving with fiber and organic technologies, and various activities such as cutting and stamping as well as 3D printing. In addition, there is a large assembly workshop in which all the products are assembled and packaged; and the quality department, guarantor of manufactured products. Nearly 40 employees make up the constantly developing industrial sector. To ensure the activities of the company, it is necessary to add 20 more collaborators who compose the sectors human resources, administration, marketing, purchases, sales, as well as 10 collaborators for the logistics sector. In the end, more than 70 employees work to perpetuate a long tradition of equipment manufacturers in the Swiss and international watchmaking sector, with a wide range of products sold in more than 110 countries. Finally, as a training company, Bergeon trains ten apprentices in the commercial, technical and logistics sector.*



CNC machine workshop CNC数控机床车间

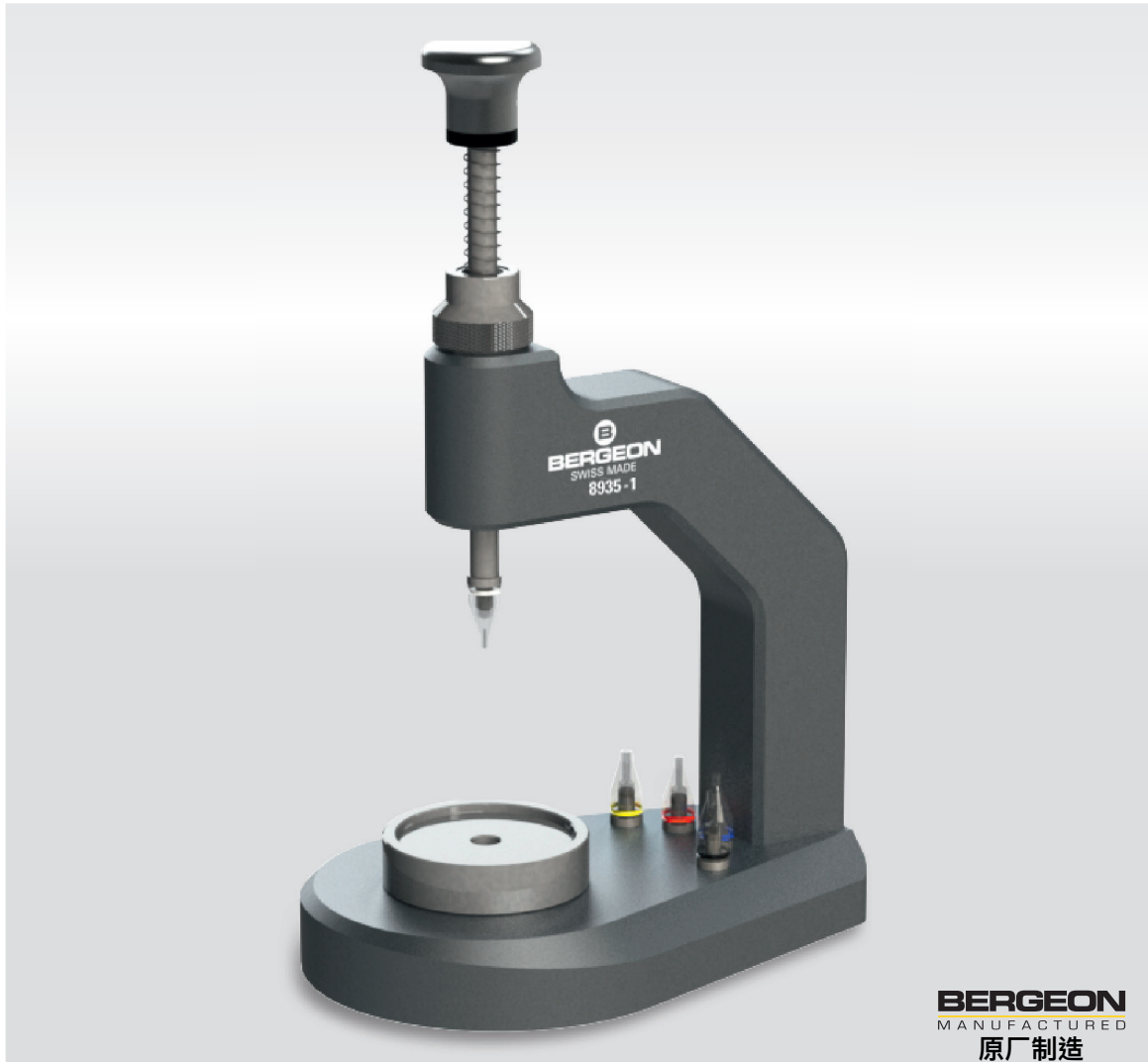

**8935-1**

SWISS MADE   
瑞士制造

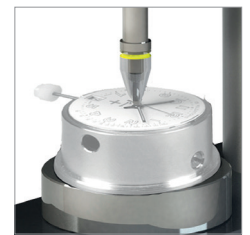

175 x 70 x 100 mm



465 g

**BERGEON**  
MANUFACTURED  
原厂制造

## 单轴装针机

精确调控安装表针

- 阳极氧化铝制成
- 合成材质压头，可快速更换，N° 8935-TC...  
Ø0.60、1.20、1.50、1.60、2.60
- 底座 Ø 31 mm
- 导引装针轴
- 装针轴/底座精确对中
- 可选配N° 7100机芯座及N° 8935-KCF力度监测仪使用



## Setting tool with 1 runner for hands

Device for precise and controlled setting of watch hands.

- Anodised aluminium structure
- Stakes made of synthetic material, quick-change
- Base Ø 31 mm
- Enhanced guidance of the spindles
- Precision alignment spindles / base
- Compatible with movement holders Bergeon N° 7100 and with the B-Force N° 8935-KCF, power sensor device



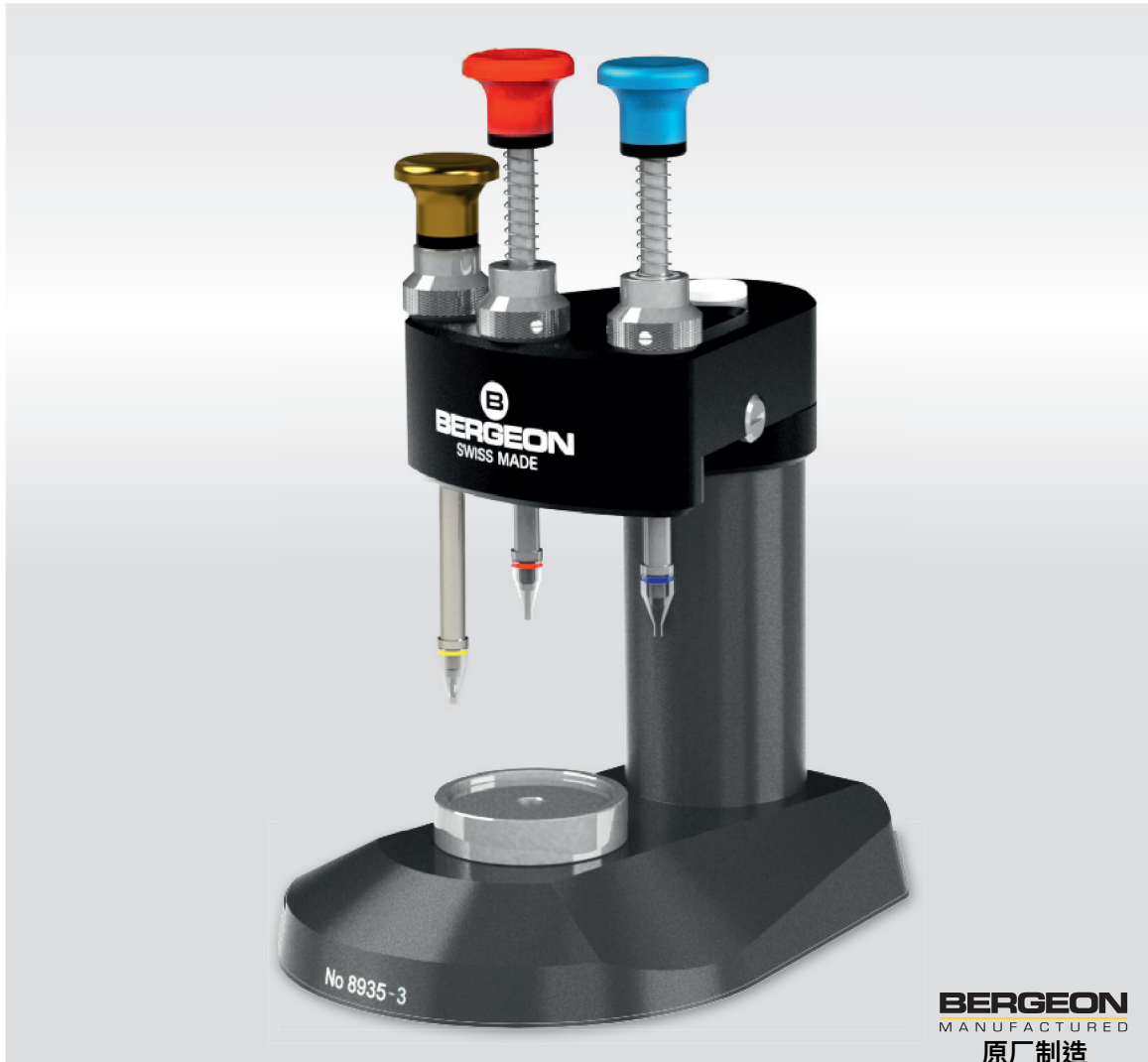

**8935-3**

SWISS MADE   
瑞士制造

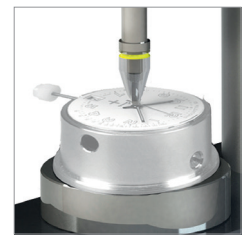

180 x 95 x 120 mm



1100 g

**BERGEON**  
MANUFACTURED  
原厂制造

### 3轴装针机

精确调控安装表针

- 阳极氧化铝制成
- 合成材质压头
- 底座 Ø 31 mm
- 导引装针轴
- 装针轴/底座精确对中
- 可选配N° 7100机芯座及N° 8935-KCF力度监测仪使用

### Setting tool with 3 runners for hands

Device for precise and controlled setting of watch hands.

- Anodised aluminium structure
- Stakes made of synthetic material
- Base Ø 31 mm
- Enhanced guidance of the spindles
- Precision alignment spindles / base
- Compatible with movement holders Bergeon N° 7100 and with the B-Force N° 8935-KCF, power sensor device





**8935**

SWISS MADE   
瑞士制造

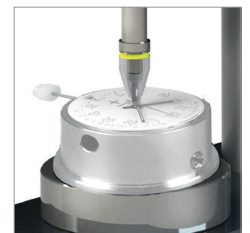

180 x 95 x 120 mm



1200 g

**BERGEON**  
MANUFACTURED  
原厂制造

## 4轴装针机

精确调控安装表针

- 阳极氧化铝制成
- 合成材质压头
- 底座 Ø 31 mm
- 导引装针轴
- 装针轴/底座精确对中
- 可选配N° 7100机芯座及N° 8935-KCF力度监测仪使用

## Setting tool with 4 runners for hands

Device for precise and controlled setting of watch hands.

- Anodised aluminium structure
- Stakes made of synthetic material
- Base Ø 31 mm
- Enhanced guidance of the spindles
- Precision alignment spindles / base
- Compatible with movement holders Bergeon N° 7100 and with the B-Force N° 8935-KCF, power sensor device







**8935-5**

SWISS MADE   
瑞士制造

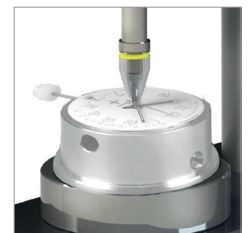

180 x 115 x 120 mm



1300 g

**BERGEON**  
MANUFACTURED  
原厂制造

## 5轴装针机

精确调控安装表针

- 阳极氧化铝制成
- 合成材质压头
- 底座 Ø 31 mm
- 导引装针轴
- 装针轴/底座精确对中
- 可选配N° 7100机芯座及N° 8935-KCF力度监测仪使用

## Setting tool with 5 runners for hands

Device for precise and controlled setting of watch hands.

- Anodised aluminium structure
- Stakes made of synthetic material
- Base Ø 31 mm
- Enhanced guidance of the spindles
- Precision alignment spindles / base
- Compatible with movement holders Bergeon N° 7100 and with the B-Force N° 8935-KCF, power sensor device







## 8935-KCF

SWISS MADE   
瑞士制造



160 x 130 x 40 mm

620 g

### 装针力度监测仪

Bergeon 专门为所有 Ø 31 mm 机芯底座的装针机而设计，精确监测装针力度。

特点：

- 符合人体工学屏幕
- 铝制外壳，可调节角度支架
- 5" 彩色屏幕
- 电压 (100-240 V / 50-60 Hz)
- 最大监测力度：200 N
- 由Bergeon研发的多种语言软件 (法/德/英/西班牙/意大利)
- 用户可设定和锁定自己的个人配置
- 二维码查询数据
- 通过微型SD卡进行存储和传输数据，及更新软件

### Power Sensor Kit for hand setting press

Device allowing an accurate and controlled drive of the watch hands. Speciall y designed by Bergeon to adapt to all hands setting press with a Ø 31 mm movement holder base, it is however adaptable according to needs.

- Sensor coupled with an ergonomic display
- Aluminum case with adjustable foot
- Colour screen, 5"
- Multi-voltage (100-240 V / 50-60 Hz)
- Maximum force: 200 N
- Multi-language Software (FR/DE/EN/SP/IT) developed by Bergeon
- Settings configurable, and lockable, by each user
- Data consultation by QR-code
- Data storage, transfer and software update by micro SD card





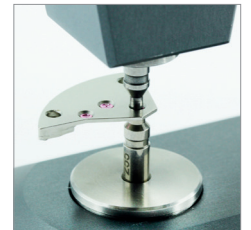

## 31300-P

SWISS MADE   
瑞士制造



185 x 100 x 60 mm

510 g

### Bergeon制造SEITZ装石机

1. 低摩擦杠杆手柄
  2. 微调精度0.01 mm
- 阳极氧化铝支架及防滑底座
  - 主轴及底座内孔为4H7
  - 工作距离：24 mm
  - 青铜轴承，减少磨损
  - 主轴可拆离
  - 可移走杠杆，用作铰孔工具
  - N° 31300套装装石机含全套附件连木盒

### SEITZ by Bergeon Jewelling tool

1. Roller lever to reduce frictional forces
  2. Micrometric adjustment to 0.01 mm of the driving height.
- Anodized aluminum frame with non-slip base
  - 4H7 reaming in spindle and base
  - Useful working height 24 mm
  - Spindle with low coefficient of friction thanks to a bronze bearing
  - Detachable spindle
  - Removable lever to use the tool as a reaming tool
  - Complete unit in wooden box N° 31300



**8250**

SWISS MADE   
瑞士制造



125 x 187 x 99 mm



840 g

### 装配手表玻璃 / 按压底盖工具

- 阳极氧化铝支架及防滑底座
- 旋转推压主轴
- 转盘Ø 100 mm
- 主轴及压胚内孔为M6螺纹
- 容纳表壳最大厚度：60 mm
- 配备：N° 5500-T21支撑轴，高度21 mm
- 可选配：N° 5500-T05支撑轴，高度 5 mm ；  
N° 5500-T28支撑轴，高度 28 mm
- 兼容N° 5499、N° 5500、N° 7499 及 N° 6527压胚

### Device for fitting glasses / snap-on case backs

- Anodized aluminum frame with non-slip base
- Linear spindle with anti-rotation
- Spoked handwheel Ø 100 mm
- Spindles and dies holders with M6 thread
- Working height for cases up to 60 mm thick
- Supplied with : die holder N° 5500-T21, height 21 mm
- Optional : die holder N° 5500-T05, height 5 mm and  
N° 5500-T28 height 28 mm
- Compatible with Dies from the range N° 5499, N° 5500,  
N° 7499 and N° 6527



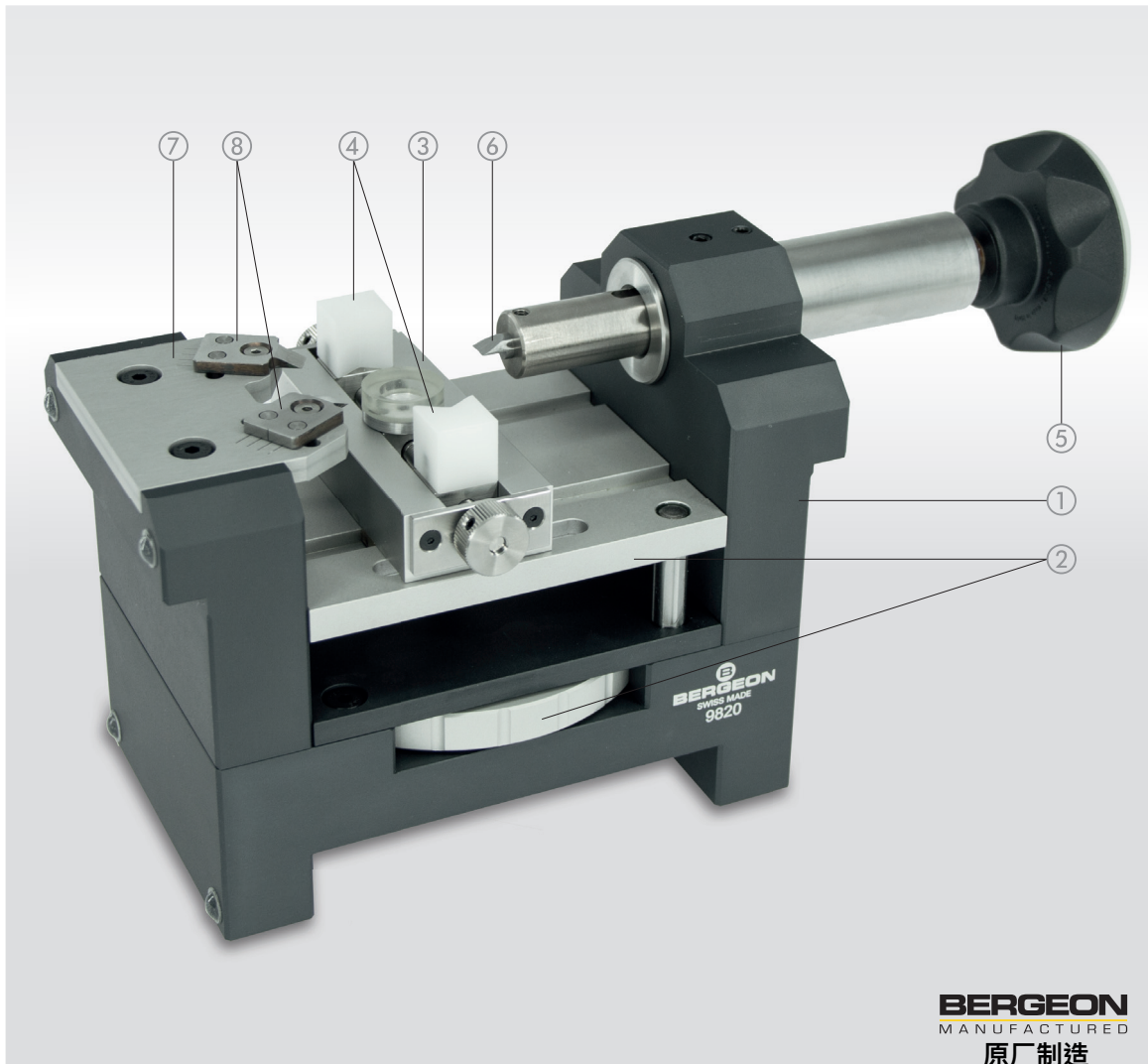

**9820**

SWISS MADE   
瑞士制造

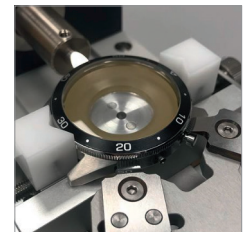

250 x 130 x 90 mm



2950 g

**BERGEON**  
MANUFACTURED  
原厂制造

## 移除按压式面圈和底盖工具

更稳固地抓紧表壳

1. 阳极氧化铝防滑底座
2. 转动旋钮，微调平台高度
3. 推动基座，使表壳接近面板刀头
4. 表耳托，可更换不同尺寸
5. 旋转推拉杆，微调刀头接近表壳
6. 57HRC硬化钢刀头，镜面抛光，编号N° 9820-C...  
20°、25°、35°或45°斜度
7. 刀头面板
8. 两把可移动的57HRC硬化钢刀头，25°斜度  
N° 9820-PCM25

## Device for removing watch pressured bezels and pressure watch cases

Compact and stable device allowing attachments to be fixed for holding the watch case by the between-horns.

1. Anodized aluminum frame and non-slip feet
2. Micrometrically height-adjustable work table
3. Adjustable vice
4. Different jaws adaptable to the between-horns
5. Anti-rotation release broache is equipped with a micrometric screw for precision work
6. Knives, made of hardened steel-tempered, 57 HRC, mirror polished, and available with angles of 20°, 25°, 35° and 45° N° 9820-C...
7. Abutment device
8. Two removable knives (having the same characteristics as those of the broach) with an angle of 25° N° 9820-PCM25

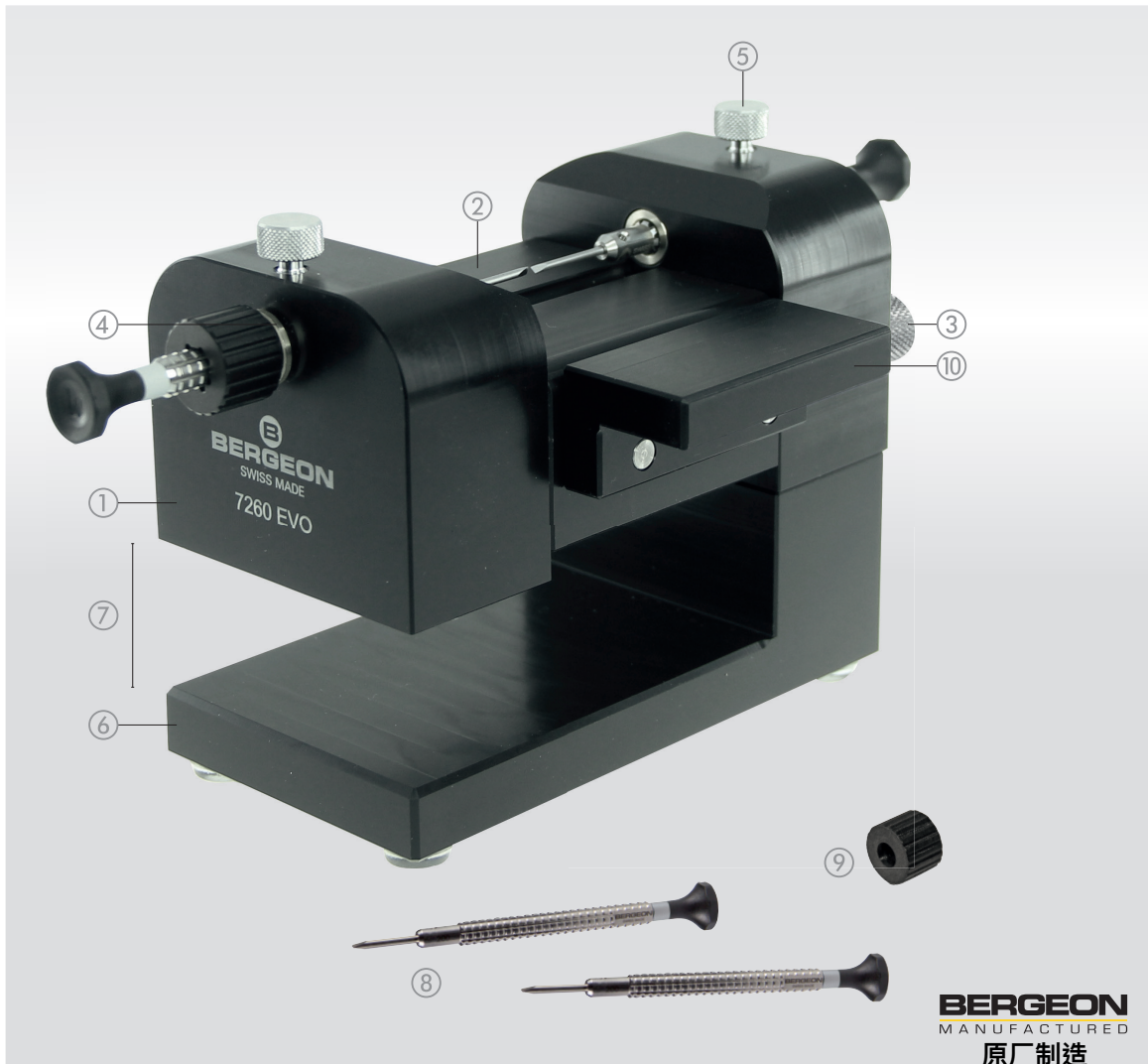

## 7260-EVO

SWISS MADE   
瑞士制造

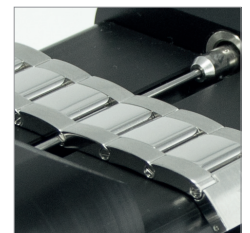

115 x 95 x 60 mm



650 g

**BERGEON**  
MANUFACTURED  
原厂制造

### 安装 / 拆除表带螺丝工具

1. Delrin®制成
2. 可调节高度平台
3. 调节平台高度旋钮
4. 圆孔可放入不同尺寸螺丝刀
5. 锁定螺丝刀装置
6. 稳固防滑底座
7. 足够表带扣通过空间
8. 2把稜纹螺丝刀 Ø 1.40 mm N° 7965-140
9. 1个加力鼓轮 N° 7965-T
10. 1个延伸扩阔平台

### Device for un/ screwing bracelets screws

1. Delrin® construction
2. Adjustable table
3. Height adjustment screw
4. Interchangeable socket for the use of various screwdriver diameters
5. Screwdrivers locking screw
6. Stable base with anti-slip pads
7. Passage for wrist strap with folding clasp
8. 2 ribbed profile screwdrivers Ø 1.40 mm N° 7965-140
9. 1 black eloxed aluminum force drum N° 7965-T
10. 1 support extension, removable





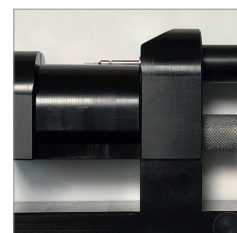
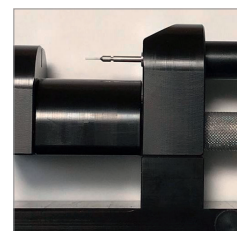

**7250**

SWISS MADE   
瑞士制造



145-175 x 100 x 50 mm

435 g

**BERGEON**  
MANUFACTURED  
原厂制造

## 装拆表带梢针工具

1. Delrin®制成
2. 可调节高度平台
3. 调节平台高度旋钮
4. 稳固防滑底座
5. 足够表带扣通过空间
6. 配备以下5支梢针 :  
7250-GC-0010 DI 0.80 - 27 mm / Ø 0.80 mm  
7250-GC-0010 DI 1.00 - 27 mm / Ø 1.00 mm  
7250-GC-0010 DI 2.50 - 20 mm / Ø 2.50 mm  
7250-GL-0010 DI 0.80 - 33 mm / Ø 0.80 mm  
7250-GL-0010 DI 1.00 - 33 mm / Ø 1.00 mm

## Horizontal device to drive in and out pins

1. Delrin® construction
2. Table with height adjustment
3. Height adjustment screw
4. Stable base with anti-slip pads
5. Passage for wrist strap with folding clasp
6. Supplied with 5 pins :  
7250-GC-0010 DI 0.80 - 27 mm / Ø 0.80 mm  
7250-GC-0010 DI 1.00 - 27 mm / Ø 1.00 mm  
7250-GC-0010 DI 2.50 - 20 mm / Ø 2.50 mm  
7250-GL-0010 DI 0.80 - 33 mm / Ø 0.80 mm  
7250-GL-0010 DI 1.00 - 33 mm / Ø 1.00 mm

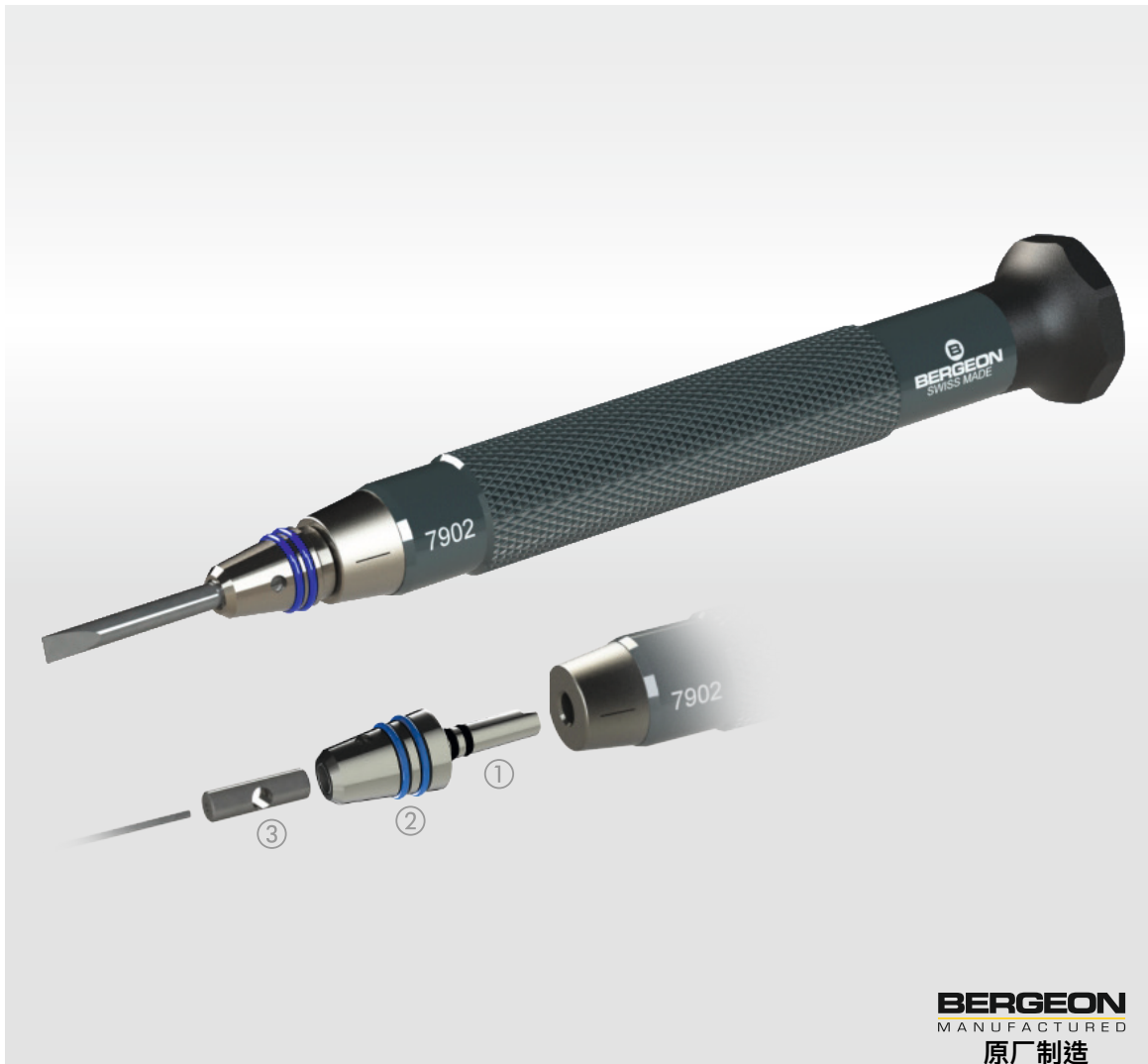

**7902-...**

SWISS MADE 



Ø 1.00 ●  
 Ø 1.20 ●  
 Ø 1.40 ●  
 Ø 1.60 ●  
 Ø 2.00 ●  
 Ø 2.50 ●  
 Ø 3.00 ●



Ø 13 x 104 mm



32 g

**BERGEON**  
MANUFACTURED  
原厂制造

### 精密螺丝刀

适用于钟表、眼镜及其他产品维修。  
配合6901-TBPR配件系列使用。

1. N° 7902-AR 不锈钢快速刀嘴转换头
2. N° 7902-OR-... 识别刀嘴尺寸颜色胶圈
3. N° 6895-D 不锈钢套筒  
外径Ø 3 mm，内径Ø 0.5至2.5 mm

- 8角形合成POM-C材质旋帽
- 阳极氧化铝手柄
- N° 6899-M 54HRC硬化不锈钢刀嘴

### Precision Screwdriver

*Suggested for Repairing, Watchmaking and Optics. Used with our accessories range N° 6901-TBPR.*

1. Quick adapter made of stainless steel N° 7902-AR
2. 2 coloured rings for the identification of the blade Ø N° 7902-OR-...
3. Reduction sleeves made of stainless steel Ø ext. of 3 mm and Ø int. of 0.5 to 2.5 mm N° 6895-D

- 8-sided head made of synthetically material POM-C
- Body made of anodised aluminium
- Blade made of hardened stainless steel 54HRC N° 6899-M

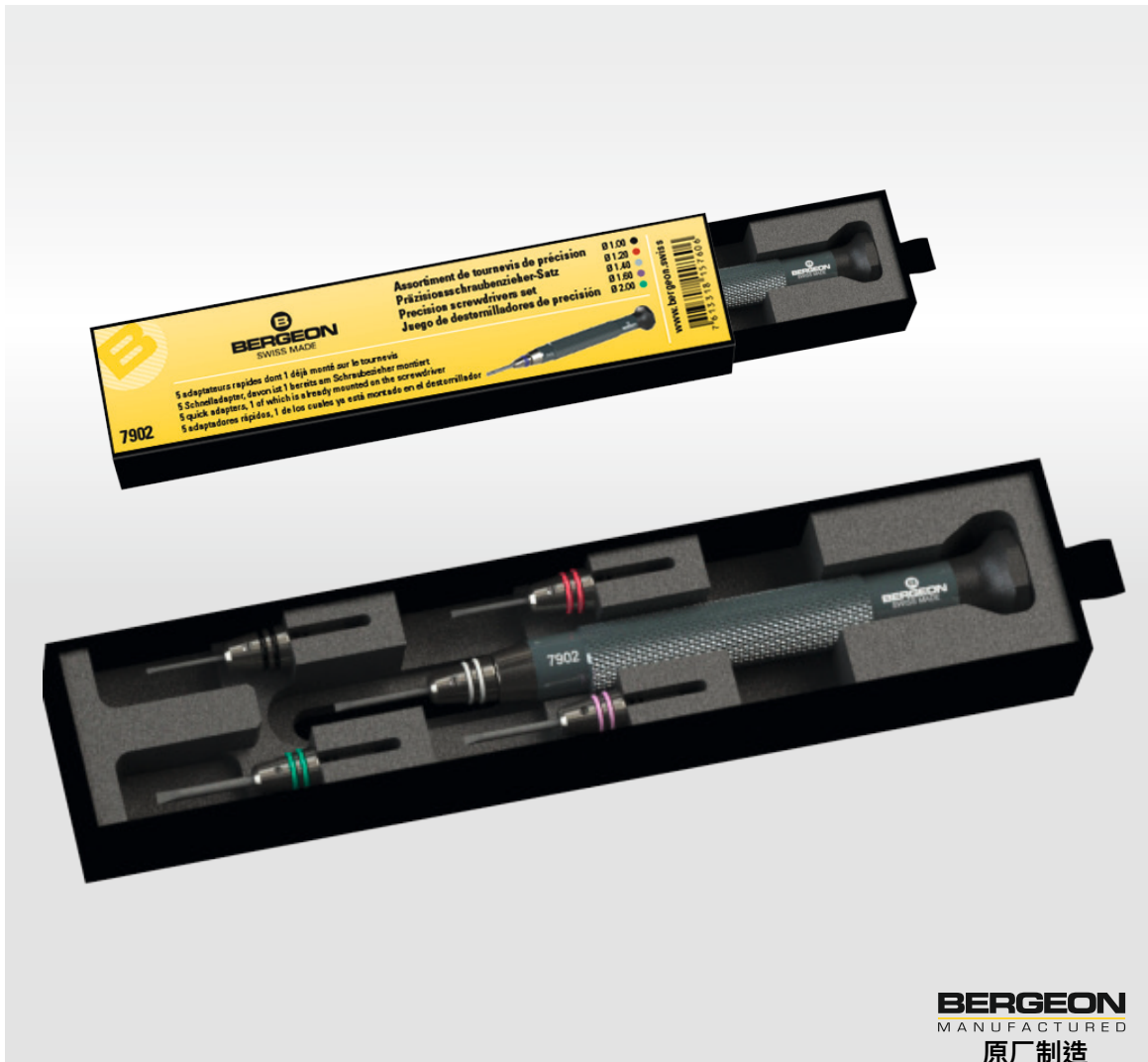

**7902**

SWISS MADE 



Ø 1.00 ●  
Ø 1.20 ●  
Ø 1.40 ●  
Ø 1.60 ●  
Ø 2.00 ●



178 x 28 x 41 mm



97 g

**BERGEON**  
MANUFACTURED  
原厂制造

### 精密螺丝刀套装

- 黑色纸盒
- 包含：
  - 5个快速刀嘴转换头(套筒、颜色胶圈及刀嘴)。
  - 1个已装在螺丝刀上

### Precision screwdrivers set

- In cardboard box, black
- Contains :
  - 5 quick adapters with reduction sleeves, blade and coloured rings for the identification, 1 of which is already mounted on the screwdriver



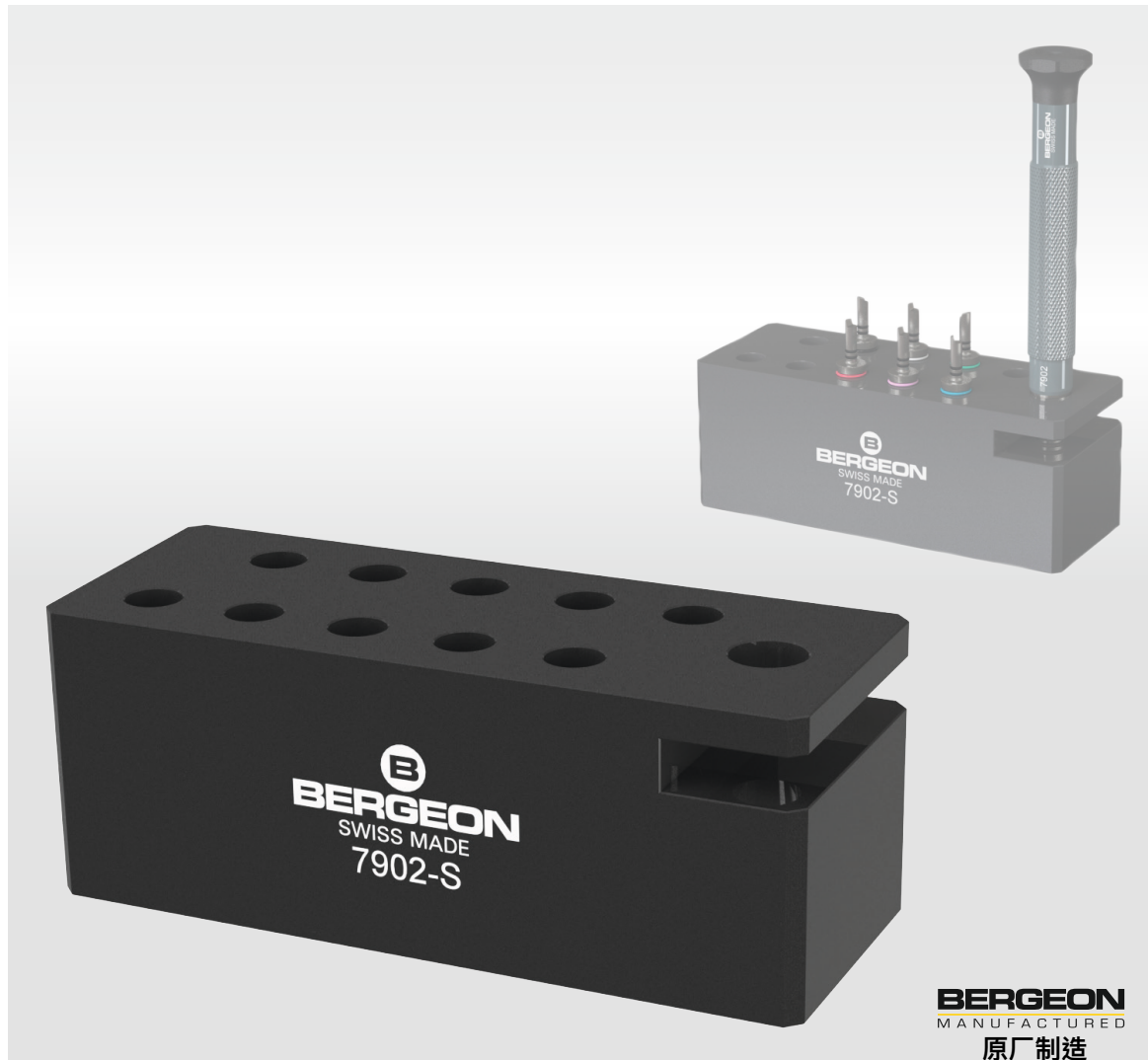



## 7902-S

SWISS MADE 





40 x 40 x 105 mm

210 g

### 精密螺丝刀底座

- 合成POM-C材质，黑色
- 稳固、防滑
- 1个N° 7902-... 精密螺丝刀插槽
- 10个N° 7902-AR 快速刀嘴转换头插槽

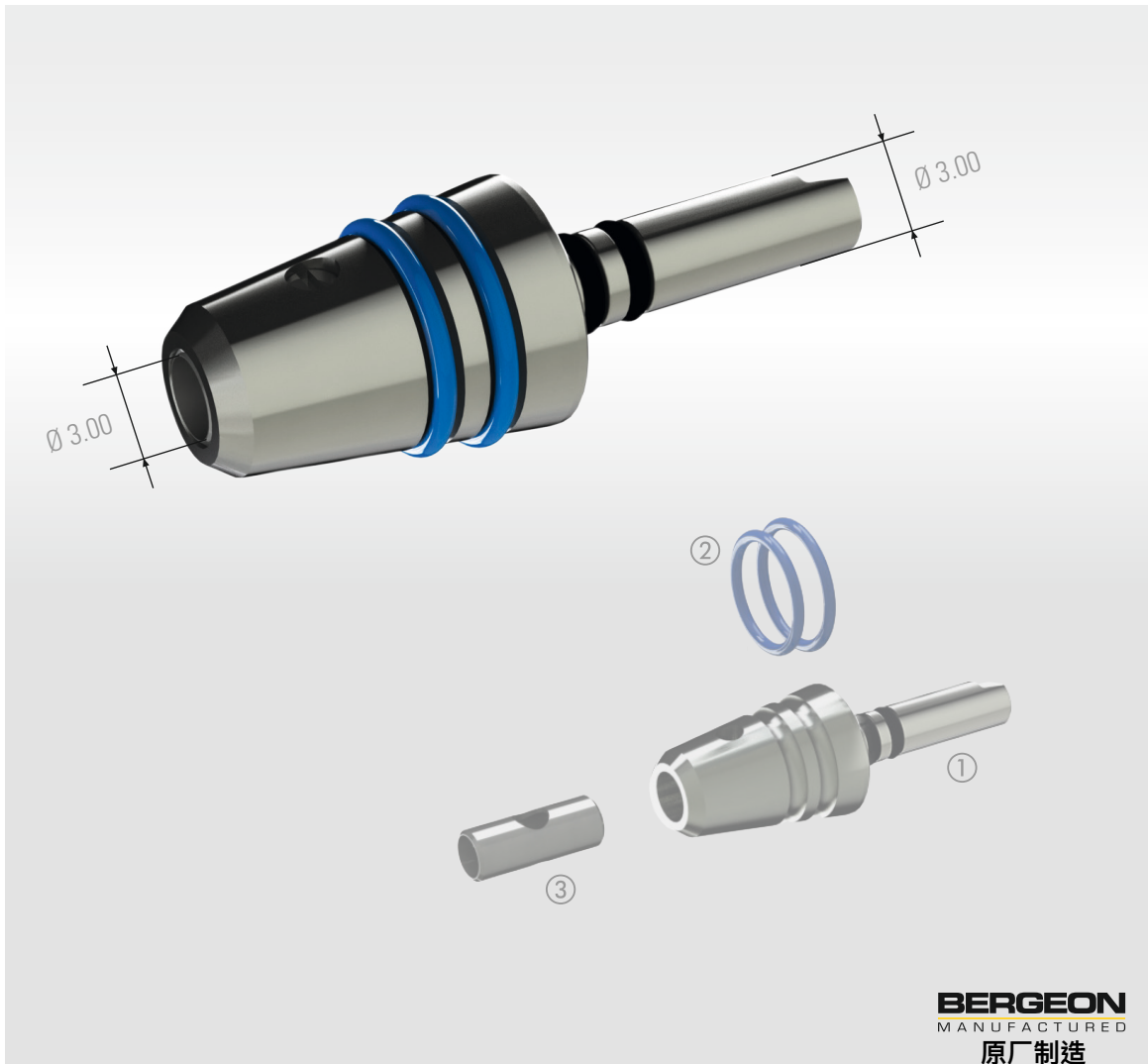
### Stand alone base for precision screwdriver

- Made of synthetic POM-C, black
- Stable, anti-slip base
- Slot for 1 precision screwdriver N° 7902-...
- Slots for 10 quick adapters N° 7902-AR



**7902-AR-...**

SWISS MADE



- Ø 1.00 ●
- Ø 1.20 ●
- Ø 1.40 ●
- Ø 1.60 ●
- Ø 2.00 ●
- Ø 2.50 ●
- Ø 3.00 ●

L : 22.5 mm
3 g

### 精密螺丝刀快速刀嘴转换头

1. 不锈钢制成
2. N° 7902-OR-... 识别刀嘴尺寸颜色胶圈
3. N° 6895-D 不锈钢套筒  
外径 Ø 3 mm  
内径 Ø 0.5 至 2.5 mm

### Quick adapter for precision screwdriver

1. Quick adapter made of stainless steel N° 7902-AR
2. 2 coloured rings for the identification of the blade Ø N° 7902-OR-...
3. Reduction sleeves made of stainless steel Ø ext. of 3 mm and Ø int. of 0.5 to 2.5 mm N° 6895-D

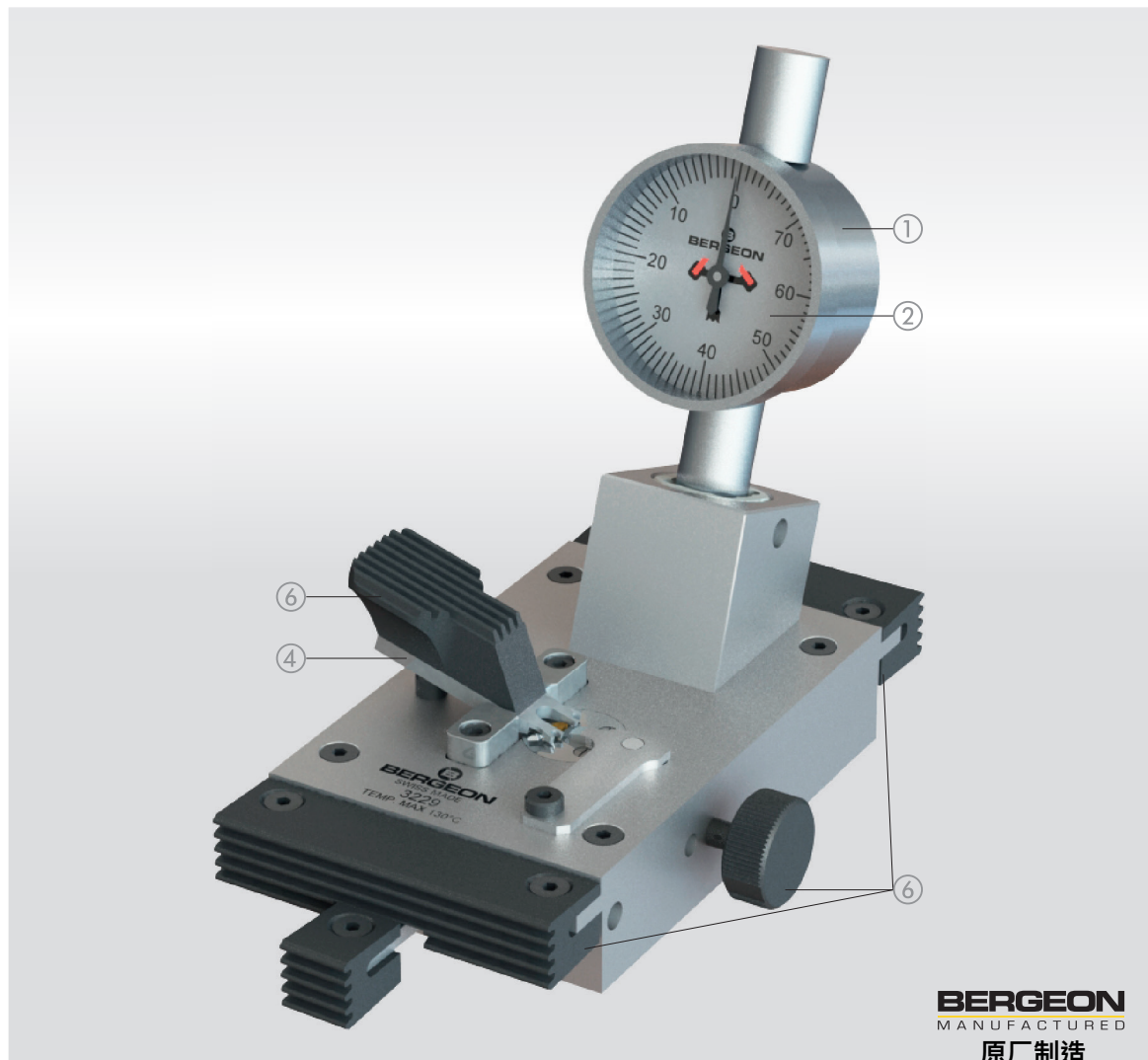

**3229-20**

SWISS MADE   
瑞士制造

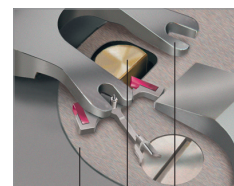

95 x 40 x 80 mm



295 g

**BERGEON**  
MANUFACTURED  
原厂制造

## 擒纵叉瓦调节器

新设计，精准调节擒纵叉瓦

1. 特大指针表盘
2. 精度：10μ
3. 定位键调节放置叉瓦空间宽度
4. 隔热杠杆夹子
5. 不锈钢承托板上2个圆孔，足够放入叉轴
6. 接触点覆盖隔热材料，耐150°C高温  
(最高操作温度~130°C)

## Escapement-tester

Device allowing a very precise adjustment of the penetration of the anchor lift. New design.

1. Central needle dial with large reading field
2. Graduation at 10μ
3. Large clearance of the flat support to the lifting
4. Clamping device by simply pressing on the lever covered with insulating material
5. Pallet's support plate, in stainless steel, with 2 centring allowing to adapt the Ø of the pallet-staff
6. Contact zone in synthetic material resistant to high temperatures 150°C. (Working temperature max ~130°C.)







## 7152-P

SWISS MADE   
瑞士制造



200 x 90 x 10 mm

180 g

### 拆除旋转表圈工具

- 阳极氧化铝制成
- 配备可互换塑料环，硬度：邵氏98
- 套装7152-3：含3个塑料环 Ø 38, 42, 46 mm
- 套装7152-6：含6个塑料环 Ø 30, 34, 38, 42, 46, 50 mm

### Plier to extract rotating bezels



- Made of anodized aluminum
- With plastic rings, hardness 98 shores, interchangeable
- Kit 7152-3 : Ø 38, 42, 46 mm
- Kit 7152-6 : Ø 30, 34, 38, 42, 46, 50 mm



### 30097-BCT

SWISS MADE   
瑞士制造



Ø 100 x 75 mm

45 g

#### 透明防尘盖子及零件盘

- 6 格
- 内径Ø 88 mm，内高：45 mm
- LURAN®塑料盖子
- 聚苯乙烯零件盘
- 可以用N° 30097-RH套筒加高
- 可以单独购买N° 30097-C盖子或N° 30097-BT 零件盘

#### Transparent cover and tray

- 6 divisions
- Ø int. : 88 mm, height under cover : 45 mm
- Cover in LURAN®
- Polystyrene tray
- Can be used with extension cover N° 30097-RH
- Cover N° 30097-C and tray N° 30097-BT can be purchased individually





### 30097-E



Ø 95 x 18 mm
160 g

### 表垫

- 内径Ø 88 mm
- 双面使用，凹面可放凸面玻璃手表；平面带保存零件凹槽
- 橡胶材质，硬度为邵氏A80
- 可选配N° 30097-C 防尘盖子及N° 30097-RH 加高套筒

### Casing cushion

- Ø int. 88 mm
- Reversible, 1 hollow side and 1 side with notch
- In rubber 80 Shores A
- Can be used with transparent cover N° 30097-C and extension cover N° 30097-RH









**7943-SC**

SWISS MADE   
瑞士制造



2x : 650 x 25 mm

2600 g

### Biflex表匠工作台吸吹尘系统

吸尘扫及吹尘笔返回原位功能(不用对重装置)

1. 锁定按钮，解锁后，吸尘扫及吹尘笔自动返回原位
- 管道可独立灵活调节，符合人体工学
  - 配备N° 8809吸尘扫及N° 7809吹尘笔

### *Biflex air-vacuum without counterweights for bench*

*Biflex system without counterweights.*

1. *With locking device.*
- *The pipes are adjustable, flexible and separable for better ergonomics*
  - *Supplied with integrated precision blower N° 7809 and acuumencil N° 8809*

## TEK - SCOPE



Utilisation avec un écran 92" recommandé  
Use with a 92" screen recommended  
建议连接92"显示器

7321

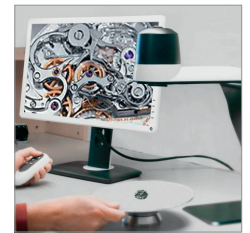

410 x 170 x 350 mm



4500 g

### 自动对焦高清显微镜

TEK-SCOPE高清显微镜是完美的检测方案，用途广泛，可连接显示器或电脑。

- 光学放大倍数 30x
- 数码放大倍数 300x
- HDMI : 全高清 1920 x 1080
- USB : 高清 1280 x 720
- 对焦 : 自动 / 手动
- 支持操作系统 : 视窗10 (不支援以前版本)
- 工作距离 : 280 mm
- ESD 防静电

### HD Autofocus Camera

The TEK-SCOPE HD Inspection System is the ultimate solution for examining a wide variety of objects in conjunction with a monitor or computer.



- Optical zoom 30x
- Digital zoom 300x
- HDMI : FHD 1920 x 1080
- USB : HD 1280 x 720
- Focus: Automatic / Manual
- Operating system : Windows 10 (earlier versions not fully supported)
- Working distance : 280 mm
- ESD Safe



**7778**

SWISS MADE   
瑞士制造



98 x 100 x 30 mm

190 g

**7778-S**

Socle seul  
Base only  
底座  
98 x 30 x 30 mm

**BERGEON**  
MANUFACTURED  
原厂制造

### 6支螺丝刀及6筒备用刀嘴套装

- 配备黑色赛钢(POM-C)底座
- 底座稳固防滑
- 含6支 N°30081螺丝刀:  
Ø 0.80, 1.00, 1.20, 1.40, 1.60, 2.00 mm  
不锈钢手柄  
N° 6899-M硬化54HRC不锈钢刀嘴  
赛钢(POM-C)旋帽
- 含6筒N° 6899-T备用刀嘴, 每筒有2支

### Stand with 6 screwdrivers and 6 tubes of blades

- Made of synthetic POM-C, black
- Stable and provided with an anti-slip film
- 6 screwdrivers N° 30081: Ø 0.80, 1.00, 1.20, 1.40, 1.60, 2.00 mm  
Body made of stainless steel  
Blade made of hardened stainless steel 54HR N° 6899-M  
Head made of synthetically material POM-C
- 6 tubes of blades N° 6899-T, containing 2 blades



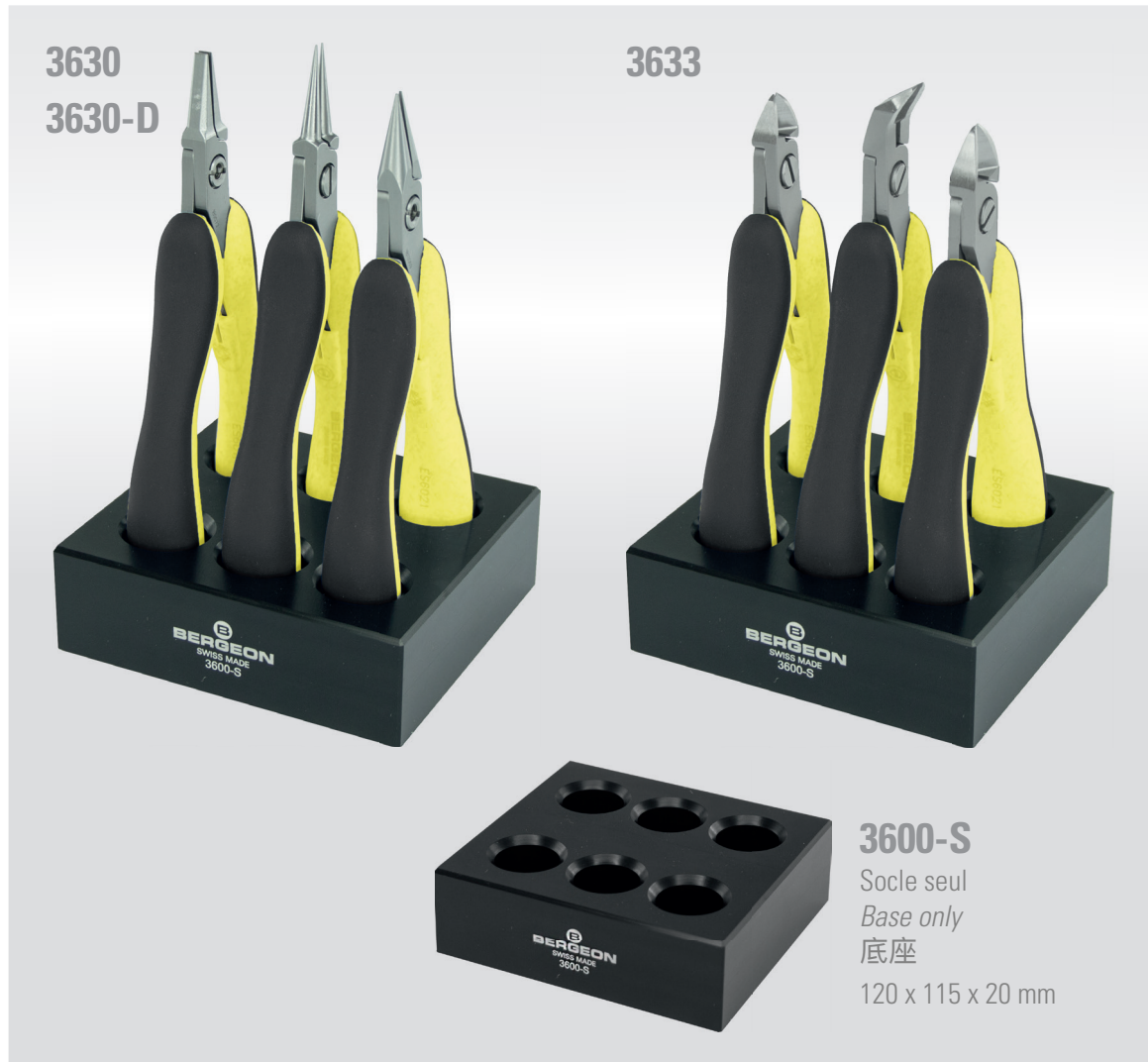



SWISS MADE   
瑞士制造

### 3600-S

Socle seul  
Base only  
底座

120 x 115 x 20 mm

120 x 115 x 133 mm

460 g

### 3把钳子套装

含黑色赛钢(POM-C)底座

- 橡胶防滑《柔软舒适》手柄
- 铬合金钢钳头
- 3630 : 含3把无齿平嘴钳子, 3624 / 3625 / 3626
- 3630-D : 含3把带齿平嘴钳子, 3624-D / 3625-D / 3626-D
- 3633 : 含3把剪钳, 3627 / 3628 / 3629

### Assortment of 3 pliers

On synthetic POM-C stand, black.



- Non-slip rubber « Soft Touch » sleeve surface
- Nosed in chrom alloyed steel
- 3630 : 3 smooth-nosed pliers, 3624 / 3625 / 3626
- 3630-D : 3 notched-nosed pliers, 3624-D / 3625-D / 3626-D
- 3633 : 3 cutting pliers, 3627 / 3628 / 3629



### 30081-HEX-P04

SWISS MADE   
瑞士制造





100 x 185 mm

70 g

#### 4支六角螺丝刀套装

- 人体工学设计自润滑赛钢(POM)旋帽
- 54/56 HRC硬化不锈钢手柄及刀嘴
-  含N° 30081-HEX 1.50, 2.00, 2.50, 3.00 mm螺丝刀

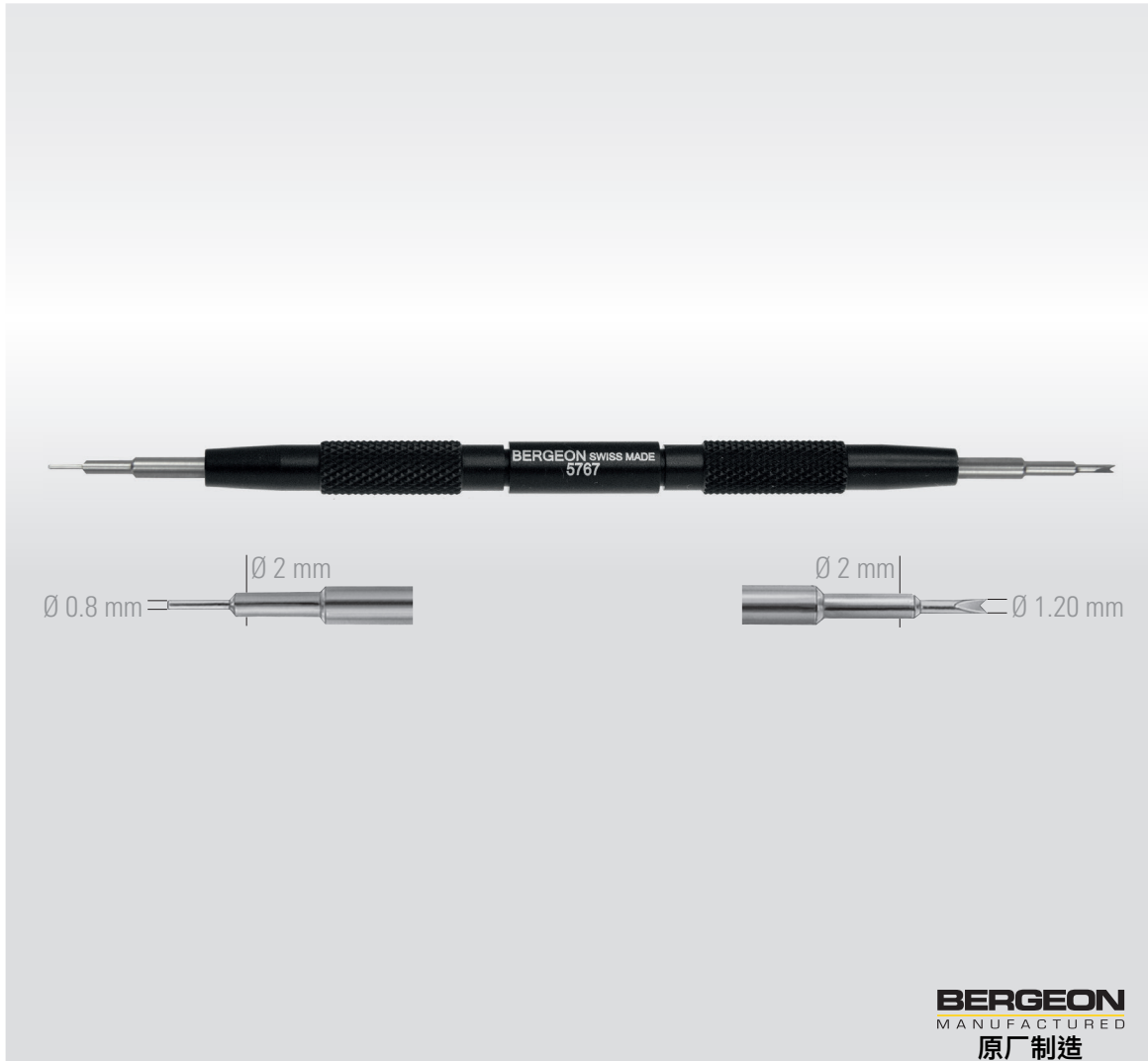
#### Set of 4 screwdrivers with hexagonal blades



- Ergonomic head made of self-lubricating POM synthetic material
- Blades and body in hardener stainless steel 54/56 HRC
-  1.50, 2.00, 2.50, 3.00 mm N° 30081-HEX



**5767-F**

SWISS MADE   
 瑞士制造



Ø 7 x 145 mm

30 g

## 装拆生耳工具

- 黑色阳极氧化铝手柄
- 硬化不锈钢纤细冲针及叉子

## Tool for fitting and removing spring-bars

- In black anodised aluminium
- With fine points and forks made of hardened stainless steel



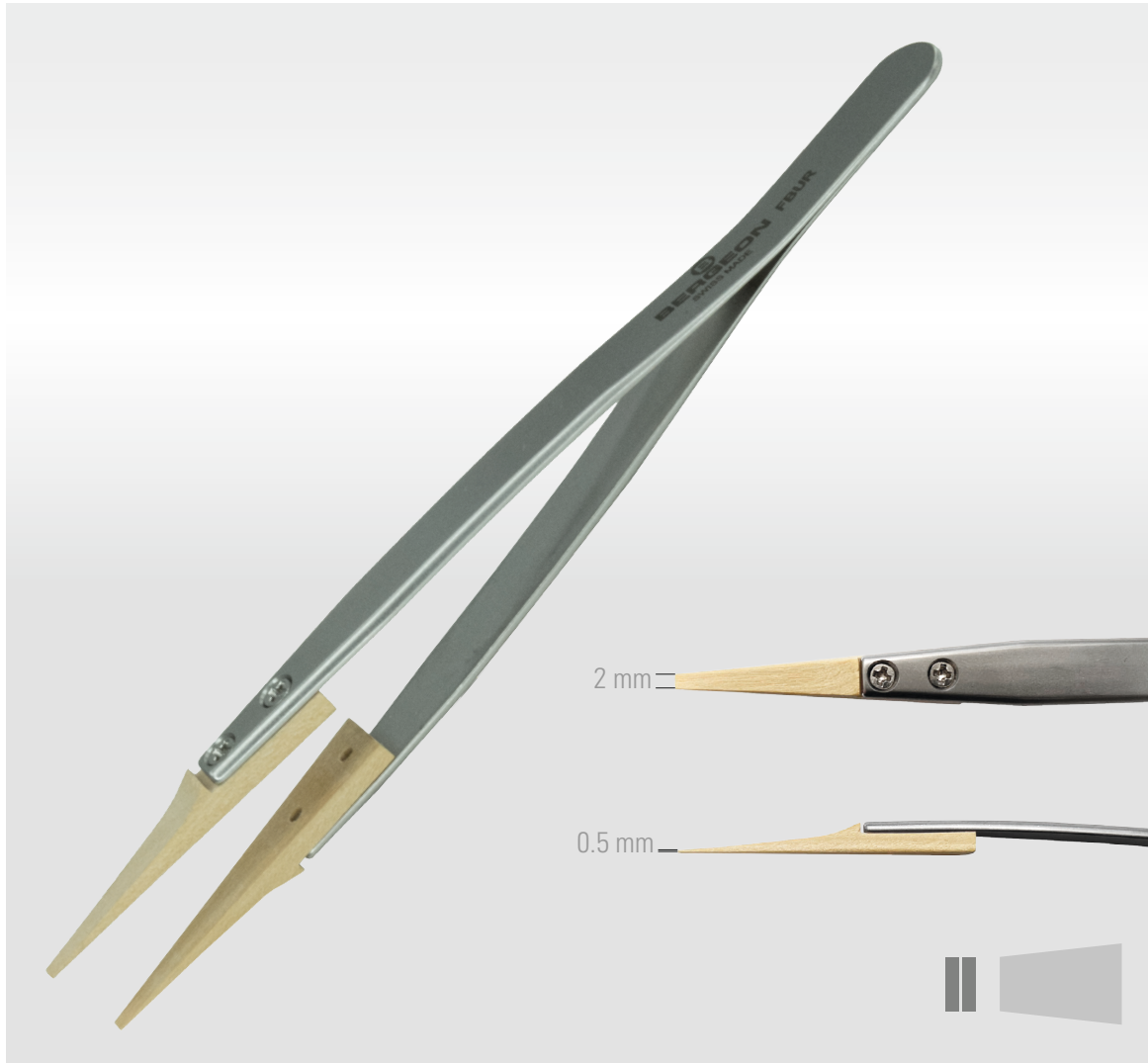



**6571-BUR-F**

SWISS MADE 



10 x 130 mm

17 g

**可换头镊子**

- 防磁钢(C, Cr and Ni)材质镊柄
- 扁平木质镊头
- 耐高温150 °C
- 工业标准抛光

**Tweezer with flat replaceable tips**

- Antimagnetic steel tweezer composed of C, Cr and Ni
- Flat replaceable tips
- Temperature resistance up to 150 °C
- Industrial standard finish



Find all our products online  
欢迎到以下官网浏览我们产品

[www.bergeon.swiss](http://www.bergeon.swiss)



**Outillages et équipements pour l'horlogerie, la bijouterie et la microtechnique**  
瑞士顶级制表、珠宝精密工具及设备